HB52RF1289E2-75B

1 GB Registered SDRAM DIMM
128-Mword \times 72-bit, 133 MHz Memory Bus, 2-Bank Module

(36 pcs of 64 M \times 4 Components)

PC133 SDRAM

HITACHI

ADE-203-1079A (Z)

Preliminary

Rev. 0.1

Aug. 10, 1999

Description

The HB52RF1289E2 belongs to 8-byte DIMM (Dual In-line Memory Module) family, and has been developed as an optimized main memory solution for 8-byte processor applications. The HB52RF1289E2 is a 64M \times 72 \times 2-bank Synchronous Dynamic RAM Module, mounted 36 pieces of 256-Mbit SDRAM (HM5225405BTB) sealed in TCP package, 1 piece of PLL clock driver, 3 pieces register driver and 1 piece of serial EEPROM (2-kbit) for Presence Detect (PD). An outline of the HB52RF1289E2 is 168-pin socket type package (dual lead out). Therefore, the HB52RF1289E2 makes high density mounting possible without surface mount technology. The HB52RF1289E2 provides common data inputs and outputs. Decoupling capacitors are mounted beside TCP on the module board.

Note: Do not push the cover or drop the modules in order to protect from mechanical defects, which would be electrical defects.

Features

- Fully compatible with: JEDEC standard outline 8-byte DIMM
- 168-pin socket type package (dual lead out)
 - Outline: 133.37 mm (length) \times 38.10 mm (Height) \times 4.80 mm (Thickness)
 - Lead pitch: 1.27 mm
- 3.3 V power supply
- Clock frequency: 133 MHz (max)
- LVTTTL interface
- Data bus width: \times 72ECC
- Single pulsed $\overline{\text{RAS}}$
- 4 Banks can operate simultaneously and independently
- Burst read/write operation and burst read/single write operation capability
- Programmable burst length: 1/2/4/8
- 2 variations of burst sequence
 - Sequential
 - Interleave

HB52RF1289E2-75B

- Programmable \overline{CE} latency: 4
- Byte control by DQMB
- Refresh cycles: 8192 refresh cycles/64 ms
- 2 variations of refresh
 - Auto refresh
 - Self refresh

Ordering Information

Type No.	Frequency	\overline{CE} latency	Package	Contact pad
HB52RF1289E2-75B	133 Mhz	4	168-pin dual lead out socket type	Gold

Pin Arrangement

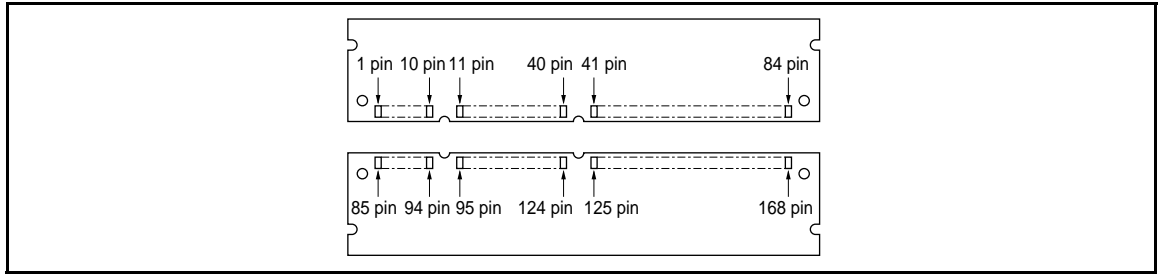

Pin No.	Pin name	Pin No.	Pin name	Pin No.	Pin name	Pin No.	Pin name
1	V _{SS}	43	V _{SS}	85	V _{SS}	127	V _{SS}
2	DQ0	44	NC	86	DQ32	128	CKE0
3	DQ1	45	$\overline{S2}$	87	DQ33	129	$\overline{S3}$
4	DQ2	46	DQMB2	88	DQ34	130	DQMB6
5	DQ3	47	DQMB3	89	DQ35	131	DQMB7
6	V _{CC}	48	NC	90	V _{CC}	132	NC
7	DQ4	49	V _{CC}	91	DQ36	133	V _{CC}
8	DQ5	50	NC	92	DQ37	134	NC
9	DQ6	51	NC	93	DQ38	135	NC
10	DQ7	52	CB2	94	DQ39	136	CB6
11	DQ8	53	CB3	95	DQ40	137	CB7
12	V _{SS}	54	V _{SS}	96	V _{SS}	138	V _{SS}
13	DQ9	55	DQ16	97	DQ41	139	DQ48
14	DQ10	56	DQ17	98	DQ42	140	DQ49
15	DQ11	57	DQ18	99	DQ43	141	DQ50
16	DQ12	58	DQ19	100	DQ44	142	DQ51
17	DQ13	59	V _{CC}	101	DQ45	143	V _{CC}
18	V _{CC}	60	DQ20	102	V _{CC}	144	DQ52
19	DQ14	61	NC	103	DQ46	145	NC
20	DQ15	62	NC	104	DQ47	146	NC
21	CB0	63	NC	105	CB4	147	REGE
22	CB1	64	V _{SS}	106	CB5	148	V _{SS}
23	V _{SS}	65	DQ21	107	V _{SS}	149	DQ53
24	NC	66	DQ22	108	NC	150	DQ54
25	NC	67	DQ23	109	NC	151	DQ55
26	V _{CC}	68	V _{SS}	110	V _{CC}	152	V _{SS}
27	\overline{W}	69	DQ24	111	\overline{CE}	153	DQ56
28	DQMB0	70	DQ25	112	DQMB4	154	DQ57
29	DQMB1	71	DQ26	113	DQMB5	155	DQ58
30	$\overline{S0}$	72	DQ27	114	$\overline{S1}$	156	DQ59
31	NC	73	V _{CC}	115	\overline{RE}	157	V _{CC}
32	V _{SS}	74	DQ28	116	V _{SS}	158	DQ60
33	A0	75	DQ29	117	A1	159	DQ61
34	A2	76	DQ30	118	A3	160	DQ62
35	A4	77	DQ31	119	A5	161	DQ63

Pin No.	Pin name	Pin No.	Pin name	Pin No.	Pin name	Pin No.	Pin name
36	A6	78	V _{SS}	120	A7	162	V _{SS}
37	A8	79	CK2	121	A9	163	CK3
38	A10 (AP)	80	NC	122	BA0	164	NC
39	BA1	81	WP	123	A11	165	SA0
40	V _{CC}	82	SDA	124	V _{CC}	166	SA1
41	V _{CC}	83	SCL	125	CK1	167	SA2
42	CK0	84	V _{CC}	126	A12	168	V _{CC}

Pin Description

Pin name	Function
A0 to \overline{A} 12	Address input Row addressA0 to A12 Column addressA0 to A9, A11
BA0/BA1	Bank select addressBA0/BA1
DQ0 to DQ63	Data input/output
CB0 to CB7	Check bit (Data input/output)
\overline{S} 0 to \overline{S} 3	Chip select input
\overline{R} E	Row enable (RAS) input
\overline{C} E	Column enable (CAS) input
\overline{W}	Write enable input
DQMB0 to DQMB7	Byte data mask
CK0 to CK3	Clock input
CKE0	Clock enable input
WP	Write protect for serial PD
REGE*1	Register enable
SDA	Data input/output for serial PD
SCL	Clock input for serial PD
SA0 to SA2	Serial address input
V _{CC}	Primary positive power supply
V _{SS}	Ground
NC	No connection

Note: 1.REGE is the Register Enable pin which permits the DIMM to operate in “buffered” mode and “registered” mode. To conform to this specification, mother boards must pull this pin to high state (“registerd” mode).

Serial PD Matrix*1

Byte No.	Function described	Bit 7	Bit 6	Bit 5	Bit 4	Bit 3	Bit 2	Bit 1	Bit 0	Hex value	Comments
0	Number of bytes used by module manufacturer	1	0	0	0	0	0	0	0	80	128
1	Total SPD memory size	0	0	0	0	1	0	0	0	08	256 byte
2	Memory type	0	0	0	0	0	1	0	0	04	SDRAM
3	Number of row addresses bits	0	0	0	0	1	1	0	1	0D	13
4	Number of column addresses bits	0	0	0	0	1	0	1	1	0B	11
5	Number of banks	0	0	0	0	0	0	1	0	02	2
6	Module data width	0	1	0	0	1	0	0	0	48	72 bit
7	Module data width (continued)	0	0	0	0	0	0	0	0	00	0 (+)
8	Module interface signal levels	0	0	0	0	0	0	0	1	01	LVTTTL
9	SDRAM cycle time (highest CE latency) 7.5 ns	0	1	1	1	0	1	0	1	75	CL = 3
10	SDRAM access from Clock (highest CE latency) 5.4 ns	0	1	0	1	0	1	0	0	54	*5
11	Module configuration type	0	0	0	0	0	0	1	0	02	ECC
12	Refresh rate/type	1	0	0	0	0	0	1	0	82	Normal (7.8125 μs) Self refresh
13	SDRAM width	0	0	0	0	0	1	0	0	04	64M × 4
14	Error checking SDRAM width	0	0	0	0	0	1	0	0	04	× 4
15	SDRAM device attributes: minimum clock delay for back-to-back random column addresses	0	0	0	0	0	0	0	1	01	1 CLK
16	SDRAM device attributes: Burst lengths supported	0	0	0	0	1	1	1	1	0F	1, 2, 4, 8
17	SDRAM device attributes: number of banks on SDRAM device	0	0	0	0	0	1	0	0	04	4
18	SDRAM device attributes: CE latency	0	0	0	0	0	1	1	0	06	2/3
19	SDRAM device attributes: S latency	0	0	0	0	0	0	0	1	01	0

HB52RF1289E2-75B

Byte No.	Function described	Bit 7	Bit 6	Bit 5	Bit 4	Bit 3	Bit 2	Bit 1	Bit 0	Hex value	Comments
20	SDRAM device attributes: \overline{W} latency	0	0	0	0	0	0	0	1	01	0
21	SDRAM device attributes	0	0	0	1	0	1	1	0	16	Registered
22	SDRAM device attributes: General	0	0	0	0	1	1	1	0	0E	$V_{CC} \pm 10\%$
23	SDRAM cycle time (2nd highest \overline{CE} latency) 10 ns	1	0	1	0	0	0	0	0	A0	CL = 2 *5
24	SDRAM access from Clock (2nd highest \overline{CE} latency) 6 ns	0	1	1	0	0	0	0	0	60	*5
25	SDRAM cycle time (3rd highest \overline{CE} latency) Undefined	0	0	0	0	0	0	0	0	00	
26	SDRAM access from Clock (3rd highest \overline{CE} latency) Undefined	0	0	0	0	0	0	0	0	00	
27	Minimum row precharge time	0	0	0	1	0	1	0	0	14	20 ns
28	Row active to row active min	0	0	0	0	1	1	1	1	0F	15 ns
29	\overline{RE} to \overline{CE} delay min	0	0	0	1	0	1	0	0	14	20 ns
30	Minimum \overline{RE} pulse width	0	0	1	0	1	1	0	1	2D	45 ns
31	Density of each bank on module 1	1	0	0	0	0	0	0	0	80	2 bank 512M byte
32	Address and command signal input setup time	0	0	0	1	0	1	0	1	15	1.5 ns*5
33	Address and command signal input hold time	0	0	0	0	1	0	0	0	08	0.8 ns*5
34	Data signal input setup time	0	0	0	1	0	1	0	1	15	1.5 ns*5
35	Data signal input hold time	0	0	0	0	1	0	0	0	08	0.8 ns*5
36 to 61	Superset information	0	0	0	0	0	0	0	0	00	Future use
62	SPD data revision code	0	0	0	0	0	0	1	0	02	JEDEC2
63	Checksum for bytes 0 to 62	1	0	1	0	0	1	0	0	A4	164
64	Manufacturer's JEDEC ID code	0	0	0	0	0	1	1	1	07	HITACHI
65 to 71	Manufacturer's JEDEC ID code	0	0	0	0	0	0	0	0	00	
72	Manufacturing location	×	×	×	×	×	×	×	×	×	*2 (ASCII- 8bit code)
73	Manufacturer's part number	0	1	0	0	1	0	0	0	48	H
74	Manufacturer's part number	0	1	0	0	0	0	1	0	42	B
75	Manufacturer's part number	0	0	1	1	0	1	0	1	35	5
76	Manufacturer's part number	0	0	1	1	0	0	1	0	32	2
77	Manufacturer's part number	0	1	0	1	0	0	1	0	52	R
78	Manufacturer's part number	0	1	0	0	0	1	1	0	46	F
79	Manufacturer's part number	0	0	1	1	0	0	0	1	31	1
80	Manufacturer's part	0	0	1	1	0	0	1	0	32	2
81	Manufacturer's part number	0	0	1	1	1	0	0	0	38	8
82	Manufacturer's part number	0	0	1	1	1	0	0	1	39	9

Byte No.	Function described	Bit 7	Bit 6	Bit 5	Bit 4	Bit 3	Bit 2	Bit 1	Bit 0	Hex value	Comments
83	Manufacturer's part number	0	1	0	0	0	1	0	1	45	E
84	Manufacturer's part number	0	0	1	1	0	0	1	0	32	2
85	Manufacturer's part number	0	0	1	0	1	1	0	1	2D	—
86	Manufacturer's part number	0	0	1	1	0	1	1	1	37	7
87	Manufacturer's part number	0	0	1	1	0	1	0	1	35	5
88	Manufacturer's part number	0	1	0	0	0	0	1	0	42	B
89	Manufacturer's part number	0	0	1	0	0	0	0	0	20	(Space)
90	Manufacturer's part number	0	0	1	0	0	0	0	0	20	(Space)
91	Revision code	0	0	1	1	0	0	0	0	30	Initial
92	Revision code	0	0	1	0	0	0	0	0	20	(Space)
93	Manufacturing date	×	×	×	×	×	×	×	×	×	Year code (BCD)
94	Manufacturing date	×	×	×	×	×	×	×	×	×	Week code (BCD)
95 to 98	Assembly serial number	*3									
99 to 125	Manufacturer specific data	—									*4
126	Reserved (Intel specification frequency)	0	1	1	0	0	1	0	0	64	
127	Reserved (Intel specification CE# latency support)	1	0	0	0	0	1	1	1	87	

- Notes:
- 1.All serial PD data are not protected. 0: Serial data, “driven Low”, 1: Serial data, “driven High”.
 - 2.Byte72 is manufacturing location code. (ex: In case of Japan, byte72 is 4AH. 4AH shows “J” on ASCII code.)
 - 3.Bytes 95 through 98 are assembly serial number.
 - 4.All bits of 99 through 125 are not defined (“1” or “0”).
 - 5.These specifications are defined based on component specification, not module.

Block Diagram

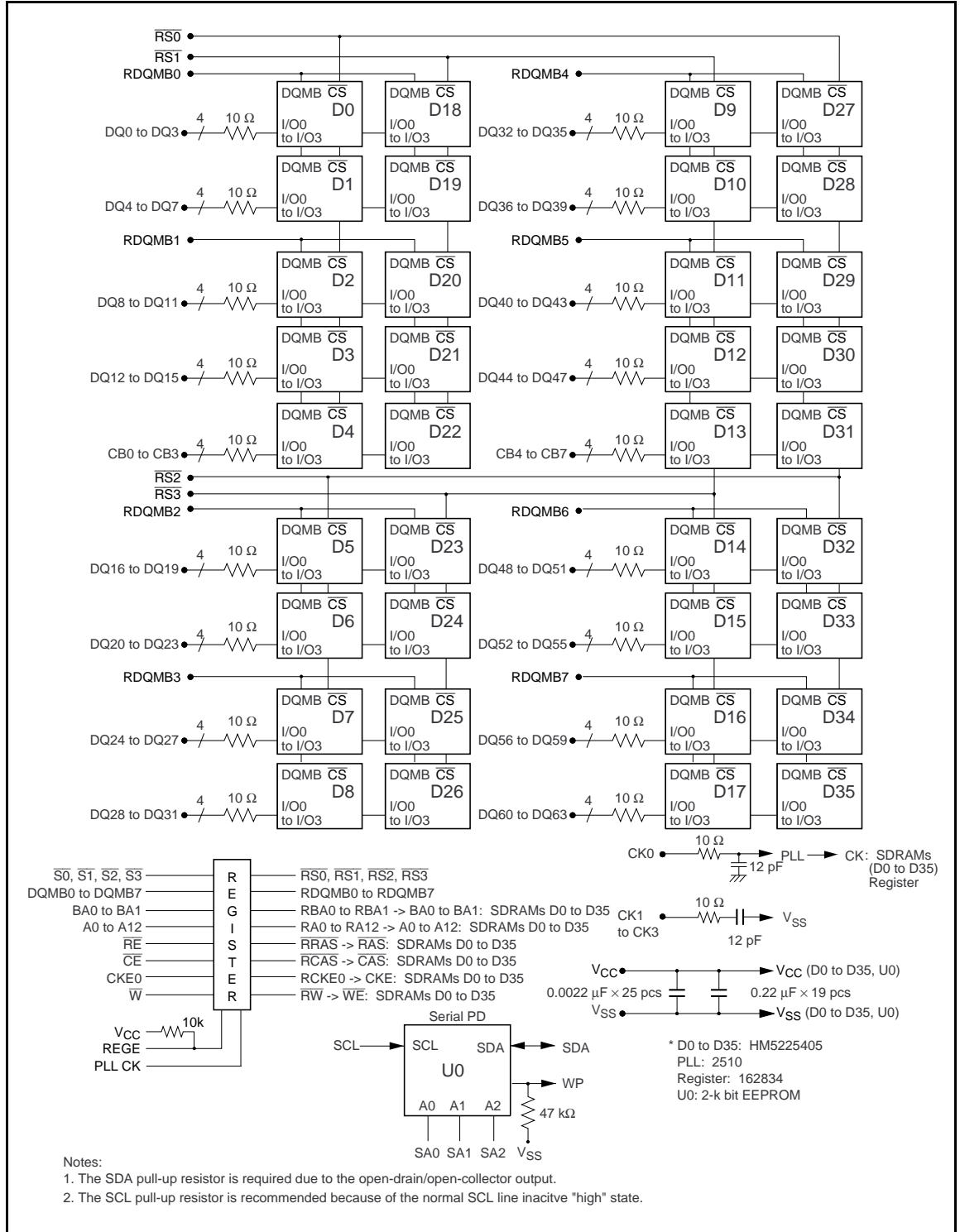

Absolute Maximum Ratings

Parameter	Symbol	Value	Unit	Note
Voltage on any pin relative to V_{SS}	V_T	-0.5 to $V_{CC} + 0.5$ (≤ 4.6 (max))	V	1
Supply voltage relative to V_{SS}	V_{CC}	-0.5 to +4.6	V	1
Short circuit output current	I_{out}	50	mA	
Power dissipation	P_T	18.0	W	
Operating temperature	T_{opr}	0 to +55	°C	
Storage temperature	T_{stg}	-50 to +100	°C	

Note: 1. Respect to V_{SS}

DC Operating Conditions ($T_a = 0$ to $+55^\circ\text{C}$)

Parameter	Symbol	Min	Max	Unit	Notes
Supply voltage	V_{CC}	3.0	3.6	V	1
	V_{SS}	0	0	V	3
Input high voltage	V_{IH}	2.0	V_{CC}	V	1, 4
Input low voltage	V_{IL}	0	0.8	V	1, 5
Ambient illuminance	—	—	100	lx	

- Notes:
1. All voltage referred to V_{SS}
 2. The supply voltage with all V_{CC} and V_{CCQ} pins must be on the same level.
 3. The supply voltage with all V_{SS} and V_{SSQ} pins must be on the same level.
 4. V_{IH} (max) = $V_{CC} + 2.0$ V for pulse width ≤ 3 ns at V_{CC} .
 5. V_{IL} (min) = $V_{SS} - 2.0$ V for pulse width ≤ 3 ns at V_{SS} .

V_{IL}/V_{IH} Clamp (Component characteristics)

This SDRAM component has V_{IL} and V_{IH} clamp for CK, CKE, \bar{S} , DQMB and DQ pins.

Minimum V_{IL} Clamp Current

V_{IL} (V)	I (mA)
-2	-32
-1.8	-25
-1.6	-19
-1.4	-13
-1.2	-8
-1	-4
-0.9	-2
-0.8	-0.6
-0.6	0
-0.4	0
-0.2	0
0	0

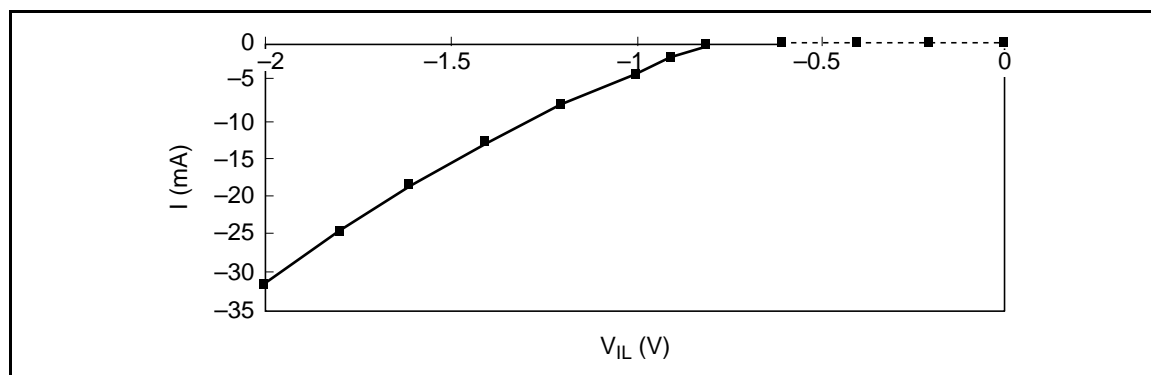

Minimum V_{IH} Clamp Current (referred to V_{IH})

V_{IH} (V)	I (mA)
$V_{CC} + 2$	10
$V_{CC} + 1.8$	8
$V_{CC} + 1.6$	5.5
$V_{CC} + 1.4$	3.5
$V_{CC} + 1.2$	1.5
$V_{CC} + 1$	0.3
$V_{CC} + 0.8$	0
$V_{CC} + 0.6$	0
$V_{CC} + 0.4$	0
$V_{CC} + 0.2$	0
$V_{CC} + 0$	0

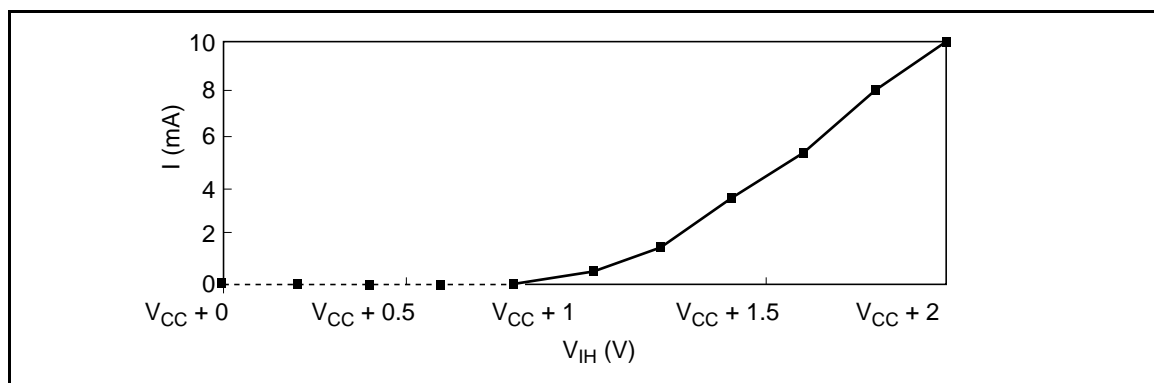

I_{OL}/I_{OH} Characteristics (Component characteristics)

Output Low Current (I_{OL})

V_{out} (V)	I_{OL}	
	Min (mA)	Max (mA)
0	0	0
0.4	27	71
0.65	41	108
0.85	51	134
1	58	151
1.4	70	188
1.5	72	194
1.65	75	203
1.8	77	209
1.95	77	212
3	80	220
3.45	81	223

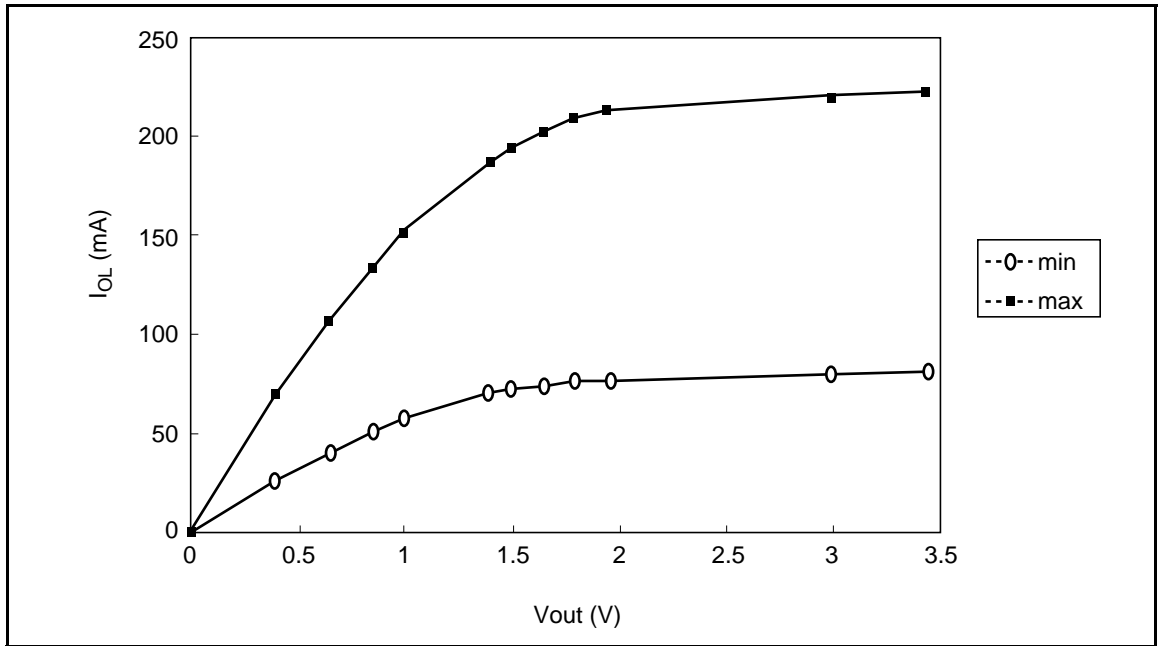

Output High Current (I_{OH}) (T_a = 0 to 55°C, V_{CC} = 3.0 V to 3.45 V, V_{SS} = 0 V)

V _{out} (V)	I _{OH} Min (mA)	I _{OH} Max (mA)
3.45	—	-3
3.3	—	-28
3	0	-75
2.6	-21	-130
2.4	-34	-154
2	-59	-197
1.8	-67	-227
1.65	-73	-248
1.5	-78	-270
1.4	-81	-285
1	-89	-345
0	-93	-503

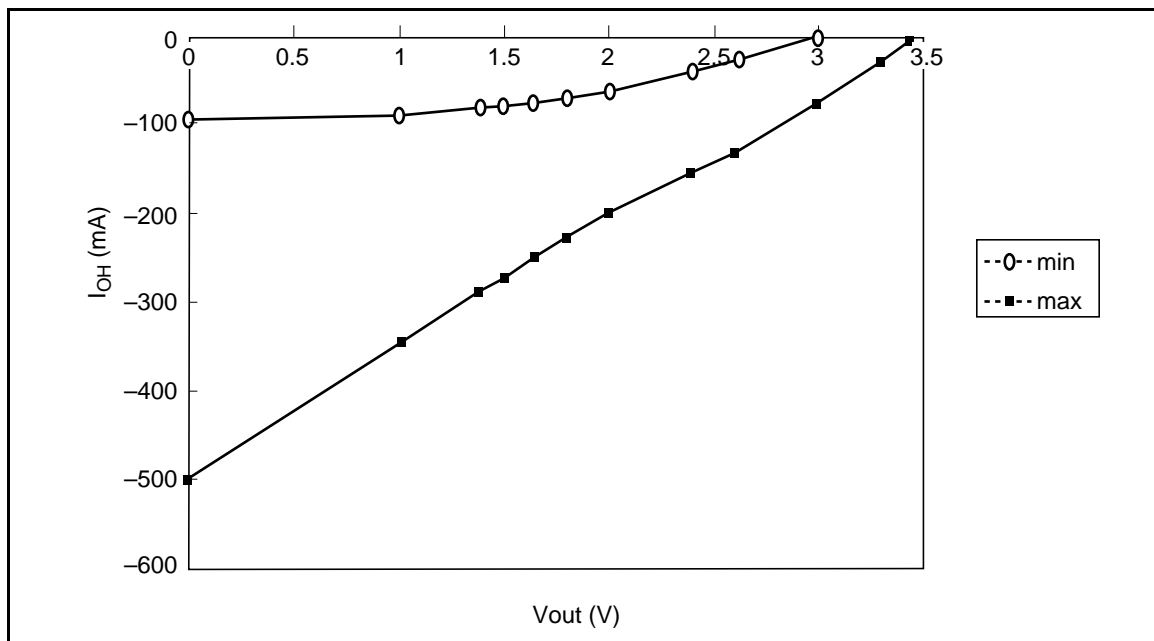

DC Characteristics (Ta = 0 to 55°C, V_{CC} = 3.3 V ± 0.3 V, V_{SS} = 0 V)

HB52RF1289E2-75B						
Parameter	Symbol	Min	Max	Unit	Test conditions	Notes
Operating current	I _{CC1}	—	3215	mA	Burst length = 1 t _{RC} = min	1, 2, 3
Standby current in power down	I _{CC2P}	—	803	mA	CKE = V _{IL} , t _{CK} = 12 ns	6
Standby current in power down (input signal stable)	I _{CC2PS}	—	767	mA	CKE = V _{IL} , t _{CK} = ∞	7
Standby current in non power down	I _{CC2N}	—	1415	mA	CKE, $\overline{S} = V_{IH}$, t _{CK} = 12 ns	4
Active standby current in power down	I _{CC3P}	—	839	mA	CKE = V _{IL} , t _{CK} = 12 ns	1, 2, 6
Active standby current in non power down	I _{CC3N}	—	1775	mA	CKE, $\overline{S} = V_{IH}$, t _{CK} = 12 ns	1, 2, 4
Burst operating current	I _{CC4}	—	3575	mA	t _{CK} = min, BL = 4	1, 2, 5
Refresh current	I _{CC5}	—	5195	mA	t _{RC} = min	3
Self refresh current	I _{CC6}	—	803	mA	V _{IH} ≥ V _{CC} - 0.2 V V _{IL} ≤ 0.2 V	8
Input leakage current	I _{LI}	-10	10	μA	0 ≤ Vin ≤ V _{CC}	
Output leakage current	I _{LO}	-10	10	μA	0 ≤ Vout ≤ V _{CC} DQ = disable	
Output high voltage	V _{OH}	2.4	—	V	I _{OH} = -4 mA	
Output low voltage	V _{OL}	—	0.4	V	I _{OL} = 4 mA	

- Notes:
1. I_{CC} depends on output load condition when the device is selected. I_{CC} (max) is specified at the output open condition.
 2. One bank operation.
 3. Input signals are changed once per one clock.
 4. Input signals are changed once per two clocks.
 5. Input signals are changed once per four clocks.
 6. After power down mode, CK operating current.
 7. After power down mode, no CK operating current.
 8. After self refresh mode set, self refresh current.

Capacitance (Ta = 25°C, V_{CC} = 3.3 V ± 0.3 V)

Parameter	Symbol	Max	Unit	Notes
Input capacitance (Address)	C _{I1}	25	pF	1, 2, 4
Input capacitance (\overline{RE} , \overline{CE} , \overline{W})	C _{I2}	25	pF	1, 2, 4
Input capacitance (CKE)	C _{I3}	45	pF	1, 2, 4
Input capacitance (\overline{S})	C _{I4}	20	pF	1, 2, 4
Input capacitance (CK)	C _{I5}	45	pF	1, 2, 4
Input capacitance (DQMB)	C _{I6}	20	pF	1, 2, 4
Input/Output capacitance (DQ)	C _{I/O1}	25	pF	1, 2, 3, 4

- Notes:
- 1.Capacitance measured with Boonton Meter or effective capacitance measuring method.
 - 2.Measurement condition: f = 1 MHz, 1.4 V bias, 200 mV swing.
 - 3.DQMB = V_{IH} to disable Data-out.
 - 4.This parameter is sampled and not 100% tested.

AC Characteristics (Ta = 0 to 55°C, V_{CC} = 3.3 V ± 0.3 V, V_{SS} = 0 V)

HB52RF1289E2-75B

Parameter	HITA- CHISym- PC100		Min	Max	Unit	Notes
	bol	Symbol				
System clock cycle time	t _{CK}	Tclk	7.5	—	ns	1
CK high pulse width	t _{CKH}	Tch	3.4	—	ns	1
CK low pulse width	t _{CKL}	Tcl	3.4	—	ns	1
Access time from CK	t _{AC}	Tac	—	6.3	ns	1, 2
Data-out hold time	t _{OH}	Toh	1.8	—	ns	1, 2
CK to Data-out low impedance	t _{LZ}		1.1	—	ns	1, 2, 3
CK to Data-out high impedance	t _{HZ}		—	6.3	ns	1, 4
Data-in setup time	t _{DS}	Tsi	2.4	—	ns	1
Data in hold time	t _{DH}	Thi	1.7	—	ns	1
Address setup time	t _{AS}	Tsi	1.9	—	ns	1
Address hold time	t _{AH}	Thi	1.5	—	ns	1, 5
CKE setup time	t _{CES}	Tsi	1.9	—	ns	1, 5
CKE setup time for power down exit	t _{CESP}	Tpde	1.9	—	ns	1

AC Characteristics (Ta = 0 to 55°C, V_{CC} = 3.3 V ± 0.3 V, V_{SS} = 0 V) (cont)

HB52RF1289E2-75B

Parameter	HITA- CHISym- bol	PC100 Symbol	Min	Max	Unit	Notes
CKE hold time	t _{CEH}	Thi	1.5	—	ns	1
Command setup time	t _{CS}	Tsi	1.9	—	ns	1
Command hold time	t _{CH}	Thi	1.5	—	ns	1
Ref/Active to Ref/Active command period	t _{RC}	Trc	67.5	—	ns	1
Active to precharge command period	t _{RAS}	Tras	45	120000	ns	1
Active command to column command (same bank)	t _{RCD}	Trcd	22.5	—	ns	1
Precharge to active command period	t _{RP}	Trp	22.5	—	ns	1
Write recovery or data-in to precharge lead time	t _{DPL}	Tdpl	15	—	ns	1
Active (a) to Active (b) command period	t _{RRD}	Trrd	15	—	ns	1
Transition time (rise to fall)	t _T		1	5	ns	
Refresh period	t _{REF}		—	64	ms	

- Notes:
- 1.AC measurement assumes t_T = 1 ns. Reference level for timing of input signals is 1.5 V.
 - 2.Access time is measured at 1.5 V. Load condition is C_L = 50 pF.
 - 3.t_{LZ} (max) defines the time at which the outputs achieves the low impedance state.
 - 4.t_{HZ} (max) defines the time at which the outputs achieves the high impedance state.
 - 5.t_{CEs} defines CKE setup time to CK rising edge except power down exit command.

Test Conditions

- Input and output timing reference levels: 1.5 V
- Input waveform and output load: See following figures
- Ambient illuminance: Under 100 lx
-

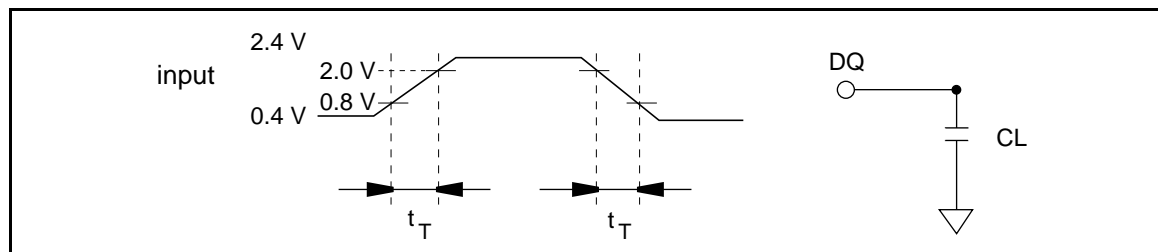

Relationship Between Frequency and Minimum Latency

Parameter	HB52RF1289E2-75B			
Frequency (MHz)	133			
t_{CK} (ns)	HITA-CHI Symbol	PC100 Symbol	7.5	Notes
Active command to column command (same bank)	I_{RCD}		3	1
Active command to active command (same bank)	I_{RC}		9	= [I_{RAS} + I_{RP}] 1
Active command to precharge command (same bank)	I_{RAS}		6	1
Precharge command to active command (same bank)	I_{RP}		3	1
Write recovery or data-in to precharge command (same bank)	I_{DPL}	T_{dpl}	2	1
Active command to active command (different bank)	I_{RRD}		2	1
Self refresh exit time	I_{SREX}	T_{srx}	2	2
Last data in to active command (Auto precharge, same bank)	I_{APW}	T_{dal}	5	= [I_{DPL} + I_{RP}]
Self refresh exit to command input	I_{SEC}		9	= [I_{RC}] 3
Precharge command to high impedance	I_{HZP}	T_{roh}	4	
Last data out to active command (Auto precharge, same bank)	I_{APR}		0	
Last data out to precharge (early precharge)	I_{EP}		-3	
Column command to column command	I_{CCD}	T_{ccd}	1	
Write command to data in latency	I_{WCD}	T_{dwd}	1	
DQMB to data in	I_{DID}	T_{dqm}	1	
DQMB to data out	I_{DOD}	T_{dqz}	3	
CKE to CK disable	I_{CLE}	T_{cke}	2	
Register set to active command	I_{RSA}	T_{mrd}	3	
\overline{S} to command disable	I_{CDD}		0	
Power down exit to command input	I_{PEC}		1	

Pin Functions

CK0 to CK3 (input pin): CK is the master clock input to this pin. The other input signals are referred at CK rising edge.

$\overline{S0}$ to $\overline{S3}$ (input pin): When \overline{S} is Low, the command input cycle becomes valid. When \overline{S} is High, all inputs are ignored. However, internal operations (bank active, burst operations, etc.) are held.

\overline{RE} , \overline{CE} and \overline{W} (input pins): Although these pin names are the same as those of conventional DRAMs, they function in a different way. These pins define operation commands (read, write, etc.) depending on the combination of their voltage levels. For details, refer to the command operation section.

A0 to A12 (input pins): Row address (AX0 to AX12) is determined by A0 to A12 level at the bank active command cycle CK rising edge. Column address (AY0 to AY9, AY11) is determined by A0 to A9, A11 level at the read or write command cycle CK rising edge. And this column address becomes burst access start address. A10 defines the precharge mode. When A10 = High at the precharge command cycle, all banks are precharged. But when A10 = Low at the precharge command cycle, only the bank that is selected by BA0/BA1 (BA) is precharged.

BA0/BA1 (input pin): BA0/BA1 are bank select signal (BA). The memory array is divided into bank 0, bank 1, bank 2 and bank 3. If BA0 is Low and BA1 is Low, bank 0 is selected. If BA0 is High and BA1 is Low, bank 1 is selected. If BA0 is Low and BA1 is High, bank 2 is selected. If BA0 is High and BA1 is High, bank 3 is selected.

CKE0 (input pin): This pin determines whether or not the next CK is valid. If CKE is High, the next CK rising edge is valid. If CKE is Low, the next CK rising edge is invalid. This pin is used for power-down and clock suspend modes.

DQMB0 to DQMB7 (input pins): Read operation: If DQMB is High, the output buffer becomes High-Z. If the DQMB is Low, the output buffer becomes Low-Z.

Write operation: If DQMB is High, the previous data is held (the new data is not written). If DQMB is Low, the data is written.

DQ0 to DQ63, CB0 to CB7 (input/output pins): Data is input to and output from these pins.

V_{CC} (power supply pins): 3.3 V is applied.

V_{SS} (power supply pins): Ground is connected.

REGE (input pins): If REGE is High, the register is “registered“ mode. If REGE is Low, the register is “buffered“ mode.

Detailed Operation Part

Refer to the HM5225165B/HM5225805B/HM5225405B-75/A6/B6 datasheet.

Physical outline

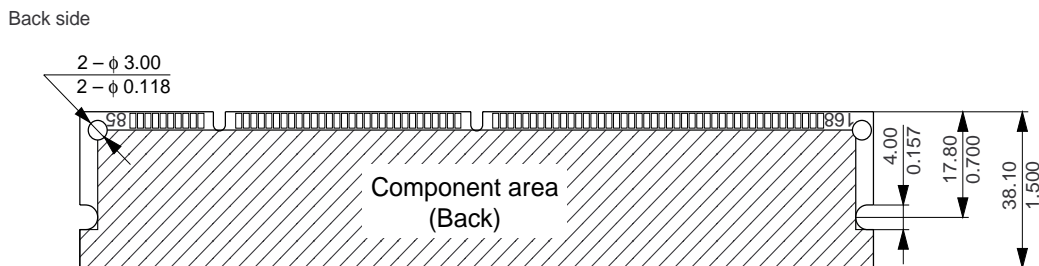
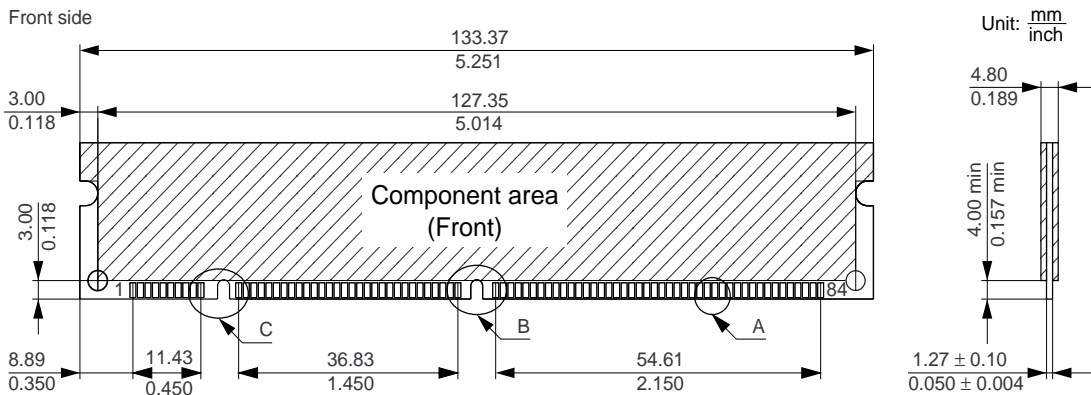

Detail A

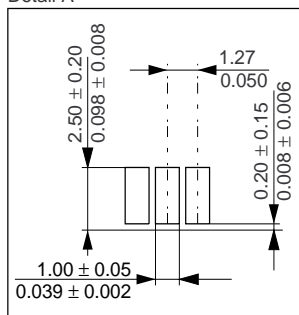

Detail B

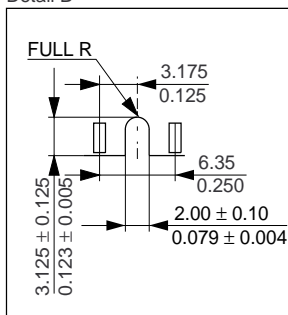

Detail C

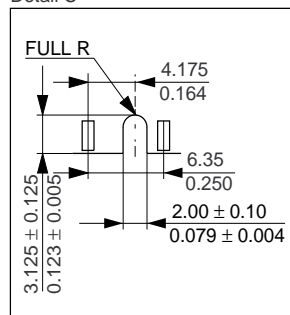

Note: Tolerance on all dimensions ± 0.15/0.006 unless otherwise specified.

Cautions

1. Hitachi neither warrants nor grants licenses of any rights of Hitachi's or any third party's patent, copyright, trademark, or other intellectual property rights for information contained in this document. Hitachi bears no responsibility for problems that may arise with third party's rights, including intellectual property rights, in connection with use of the information contained in this document.
2. Products and product specifications may be subject to change without notice. Confirm that you have received the latest product standards or specifications before final design, purchase or use.
3. Hitachi makes every attempt to ensure that its products are of high quality and reliability. However, contact Hitachi's sales office before using the product in an application that demands especially high quality and reliability or where its failure or malfunction may directly threaten human life or cause risk of bodily injury, such as aerospace, aeronautics, nuclear power, combustion control, transportation, traffic, safety equipment or medical equipment for life support.
4. Design your application so that the product is used within the ranges guaranteed by Hitachi particularly for maximum rating, operating supply voltage range, heat radiation characteristics, installation conditions and other characteristics. Hitachi bears no responsibility for failure or damage when used beyond the guaranteed ranges. Even within the guaranteed ranges, consider normally foreseeable failure rates or failure modes in semiconductor devices and employ systemic measures such as fail-safes, so that the equipment incorporating Hitachi product does not cause bodily injury, fire or other consequential damage due to operation of the Hitachi product.
5. This product is not designed to be radiation resistant.
6. No one is permitted to reproduce or duplicate, in any form, the whole or part of this document without written approval from Hitachi.
7. Contact Hitachi's sales office for any questions regarding this document or Hitachi semiconductor products.

HITACHI

Hitachi, Ltd.

Semiconductor & Integrated Circuits.

Nippon Bldg., 2-6-2, Ohte-machi, Chiyoda-ku, Tokyo 100-0004, Japan

Tel: Tokyo (03) 3270-2111 Fax: (03) 3270-5109

URL	North America	: http://semiconductor.hitachi.com/
	Europe	: http://www.hitachi-eu.com/hel/ecg
	Asia (Singapore)	: http://www.has.hitachi.com.sg/grp3/sicd/index.htm
	Asia (Taiwan)	: http://www.hitachi.com.tw/E/Product/SICD_Frame.htm
	Asia (HongKong)	: http://www.hitachi.com.hk/eng/bo/grp3/index.htm
	Japan	: http://www.hitachi.co.jp/Sicd/indx.htm

For further information write to:

Hitachi Semiconductor
(America) Inc.
179 East Tasman Drive,
San Jose, CA 95134
Tel: <1> (408) 433-1990
Fax: <1> (408) 433-0223

Hitachi Europe GmbH
Electronic components Group
Dornacher Straße 3
D-85622 Feldkirchen, Munich
Germany
Tel: <49> (89) 9 9180-0
Fax: <49> (89) 9 29 30 00

Hitachi Europe Ltd.
Electronic Components Group.
Whitebrook Park
Lower Cookham Road
Maidenhead
Berkshire SL6 8YA, United Kingdom
Tel: <44> (1628) 585000
Fax: <44> (1628) 778322

Hitachi Asia Pte. Ltd.
16 Collyer Quay #20-00
Hitachi Tower
Singapore 049318
Tel: 535-2100
Fax: 535-1533

Hitachi Asia Ltd.
Taipei Branch Office
3F, Hung Kuo Building, No.167,
Tun-Hwa North Road, Taipei (105)
Tel: <886> (2) 2718-3666
Fax: <886> (2) 2718-8180

Hitachi Asia (Hong Kong) Ltd.
Group III (Electronic Components)
7/F., North Tower, World Finance Centre,
Harbour City, Canton Road, Tsim Sha Tsui,
Kowloon, Hong Kong
Tel: <852> (2) 735 9218
Fax: <852> (2) 730 0281
Telex: 40815 HITEC HX

Copyright © Hitachi, Ltd., 1998. All rights reserved. Printed in Japan.

Revision Record

Rev.	Date	Contents of Modification	Drawn by	Approved by
0.0	Jun. 28, 1999	Initial issue (referred to HM5225165B/HM5225805B/HM5225405B-75/A6/B6 rev 0.0)	A. Nakamura	K. Tsuneda
0.1	Aug. 10, 1999	(referred to HM5225165B/HM5225805B/HM5225405B-75/A6/B6 rev 0.0) Serial PD Matrix Byte 16: 8F to 0F Byte 63: 24 to A4		
